

Lindab **NQ19**

Takdon
Monteringsanvisning



Montageanvisning

NQ19

Översikt



Tilluft

Beställningskod



CBC Monteringsanvisning

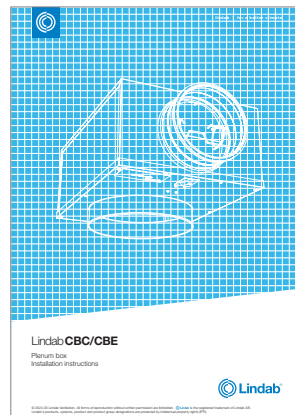

Luftdistribution - Individuellt justerbara dysor

Standard



S  Rotation

S  4-vägs

S  3-vägs

S  2-vägs

S  2-vägs (hörn)

S  1-vägs

S  Vertikal

Montageanvisning

NQ19

Dimensioner

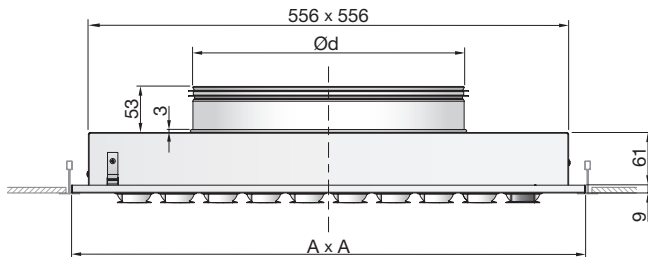

NQ19 Ød mm	Antal dysor	A mm	m kg
160	36	595	5,7
200	64	595	5,5
250	81	595	5,5
315	100	595	5,2
400	121	595	5,0

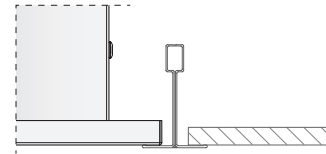

NQ19 Övre delen av donet anpassat taksystem 1

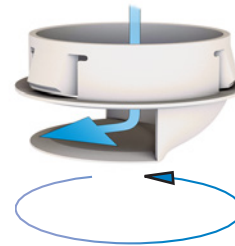

Nerfällbar front

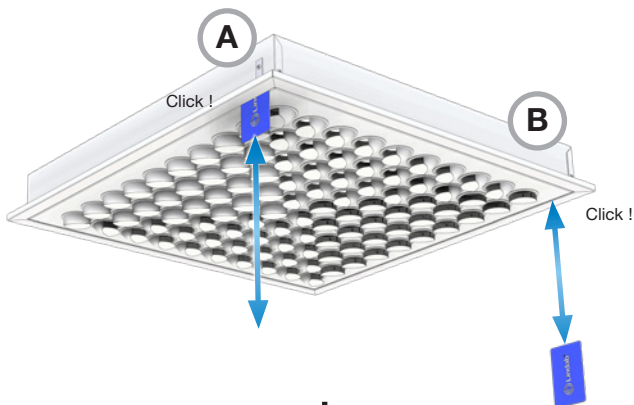

Vi rekommenderar att använda ett plastkort, som kreditkort eller liknande för att öppna fronten.

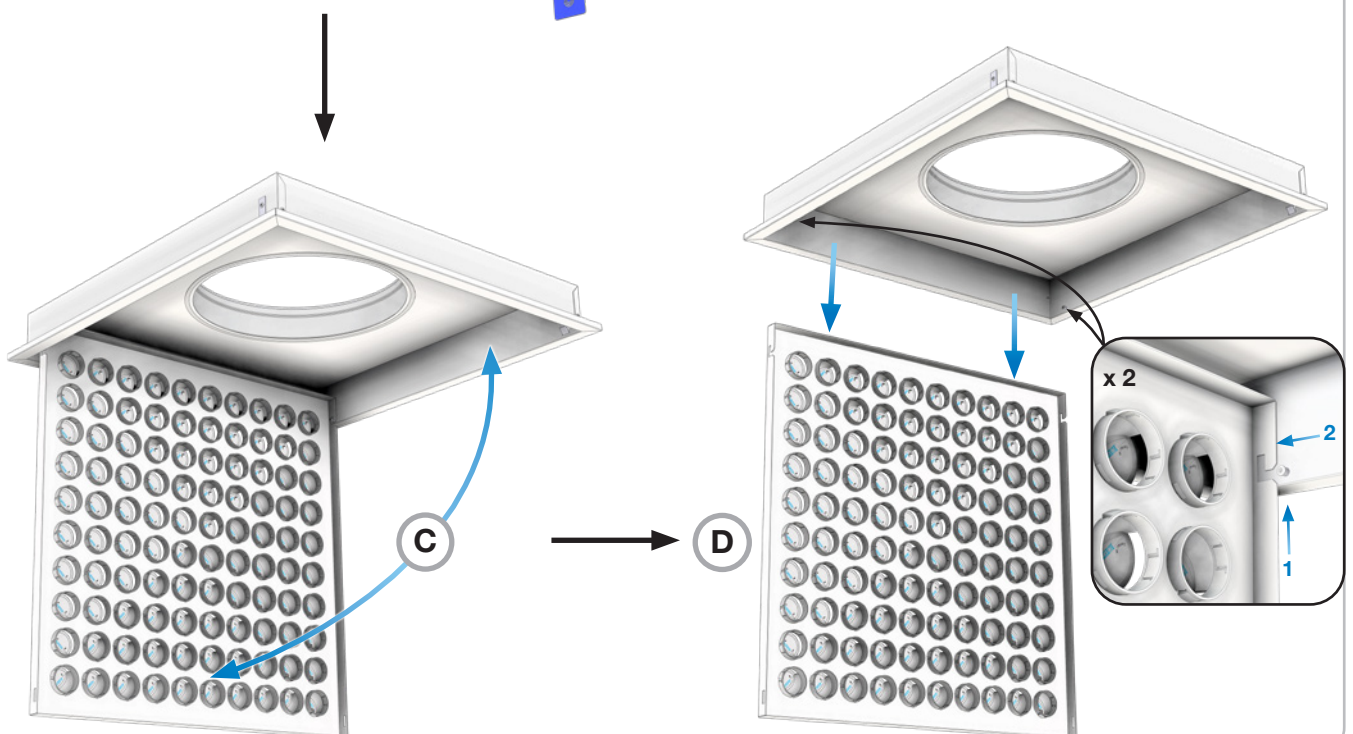

Montageanvisning

NQ19

NQ19 alternativ

NQ19-160 (36 dysor)



NQ19-200 (64 dysor)



NQ19-250 (81 dysor)



NQ19-315 (100 dysor)



NQ19-400 (121 dysor)



NQ19 + CBC anslutningslåda

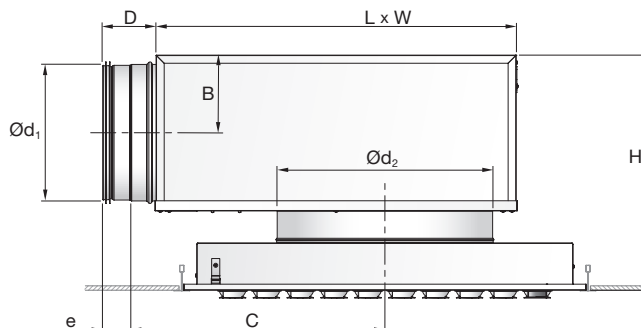

Ød ₁ mm	Ød ₂ mm	Antal dysor	B	C	D	e	H	L	W
mm									
100	160	36	65	231	78	40	248 - 286	308	244
125	160	36	78	250	78	40	273 - 311	327	244
125	200	64	78	270	78	40	273 - 311	367	284
160	200	64	95	295	78	40	307 - 345	392	284
160	250	81	95	320	78	40	307 - 345	442	334
200	250	81	115	345	78	40	347 - 385	467	334
200	315	100	115	377	78	40	347 - 385	532	399
250	315	100	140	423	118	60	398 - 436	558	399
250	400	121	140	466	118	60	398 - 436	643	484
315	400	121	173	536	118	60	463 - 501	714	484

C-spjäll

CBC

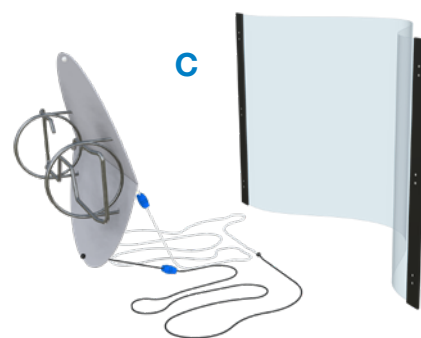

C-spjäll monterat i CB anslutningslåda

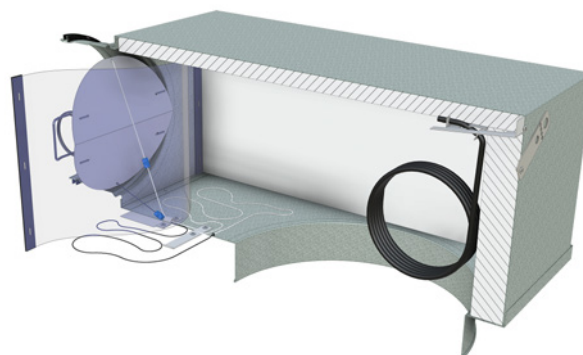

Montageanvisning

NQ19

Montering av NQ19 don i CBC anslutningslåda

A Montera CBC anslutningslåda i tak.

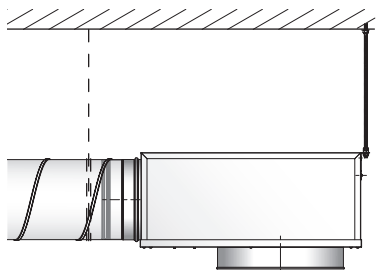

B Ta ner fronten

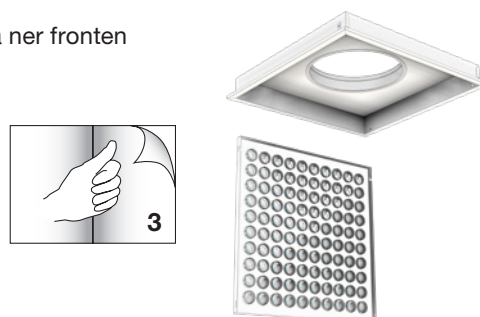

C

CBC



NQ19

D

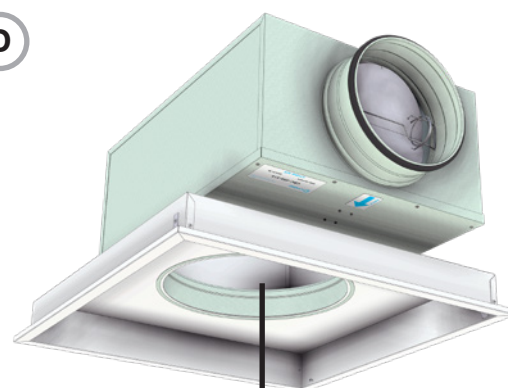

E

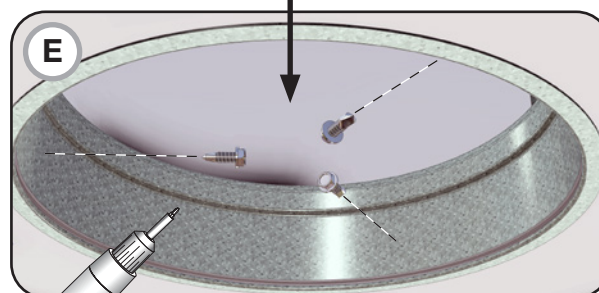

Använd självskruvande skruvar
Ingår inte.

F

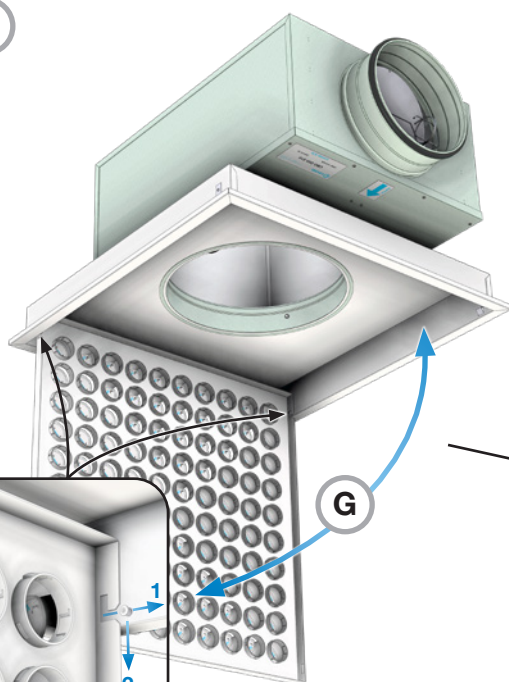

G

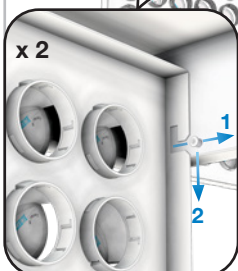

Montageanvisning

NQ19

Injustering

Gå till [montageinstruktionerna för CBC](#) för injustering och k-faktorer. Se även den [airborne calculator](#) för att konfigurera din NQ19.

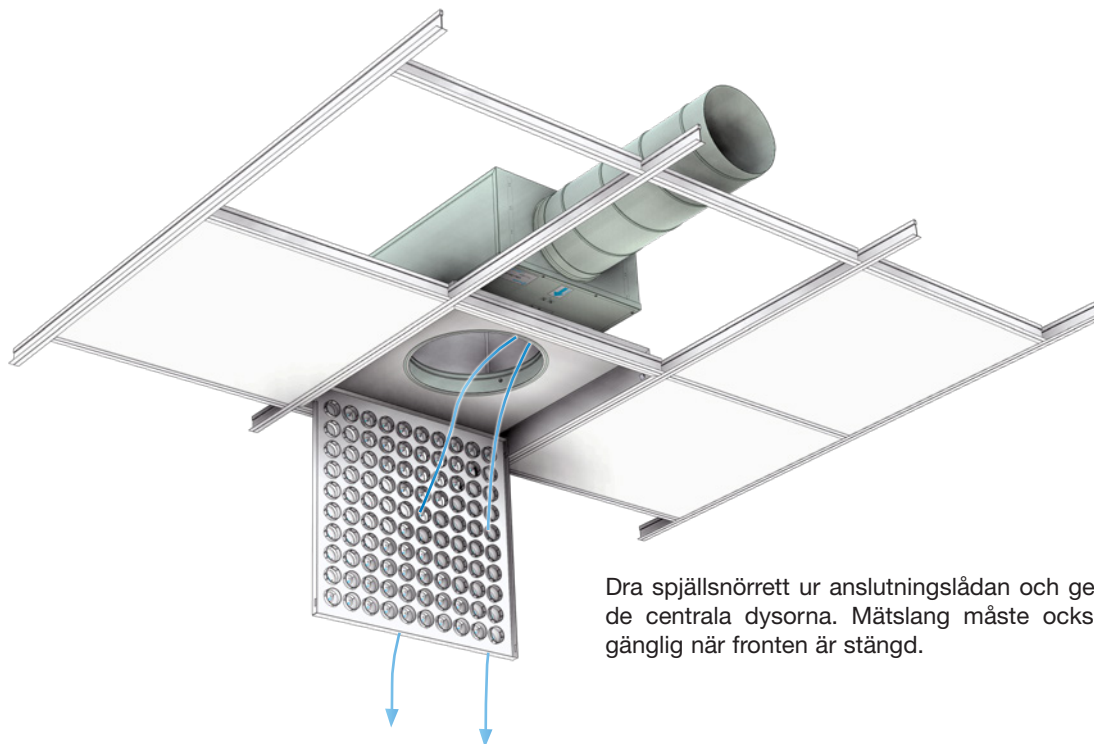

Dra spjällsnörret ur anslutningslådan och genom en av de centrala dysorna. Mät slang måste också vara tillgänglig när fronten är stängd.

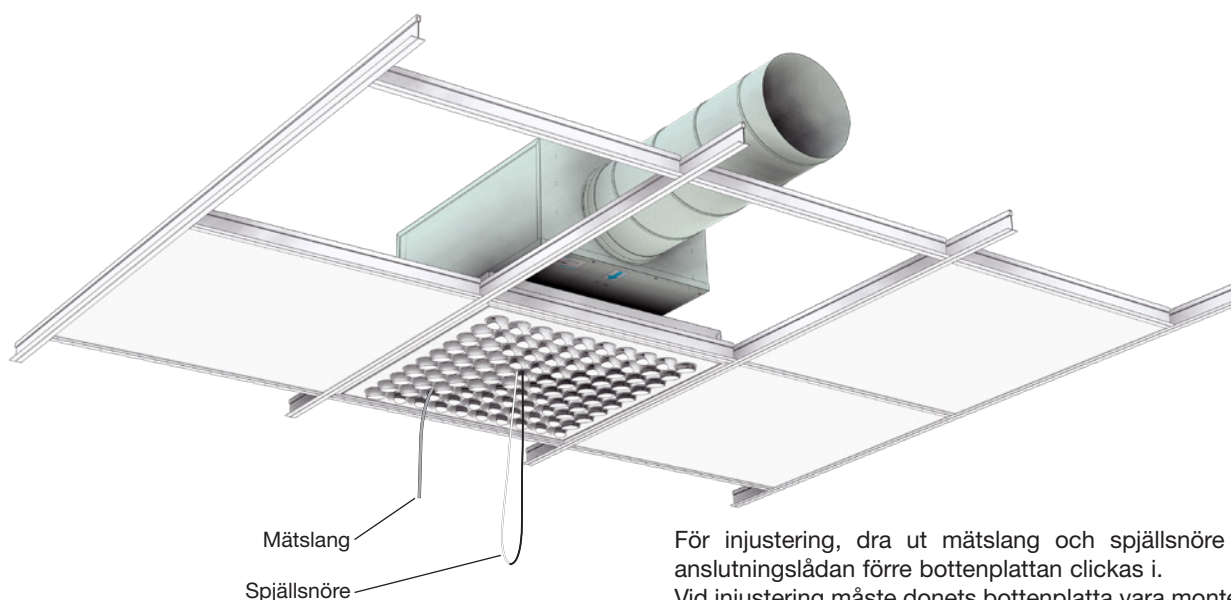

För injustering, dra ut mät slang och spjällsnöre från anslutningslådan förre bottenplattan clickas i. Vid injustering måste donets bottenplatta vara monterad!

Underhåll

Den nerfällbara fronten kan enkelt öppnas och tas av för rengöring av insidan och komma åt anslutningslådan eller kanalen. De synliga delarna av donet kan torkas av med en fuktig trasa. Spjället i anslutningslådan kan också tas ut för att ge full tillgång till tilluftskanalen. Se [CBC montageinstruktionen](#) för detaljer.

Montageanvisning

NQ19

Luftdistribution - Individuellt justerbara dysor.

Som exempel visas NQ19-315 med 100 dysor med olika spridningsbilder. Donet levereras som standard med dysor inställda på ett virvelmönster (rotationsmönster).

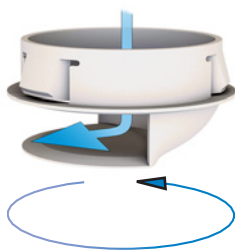

Standard

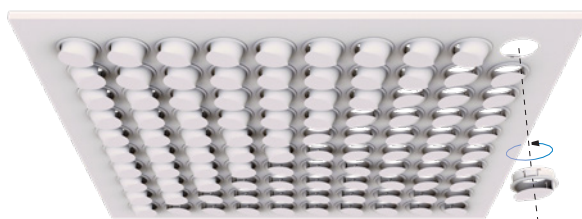

S  Rotation

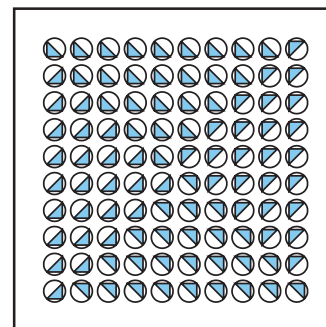

S  4-vägs

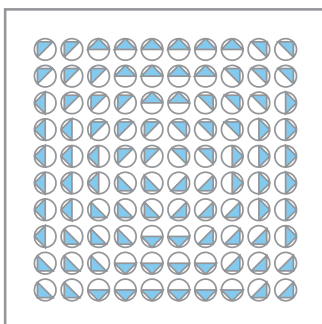

S  3-vägs

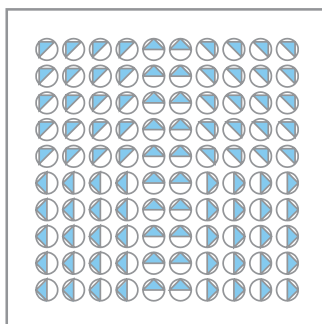

S  2-vägs

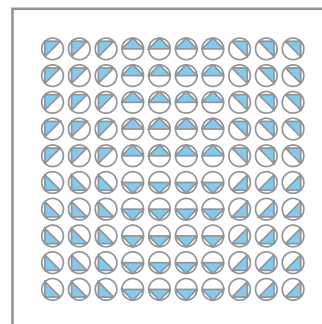

S  2-vägs (hörn)

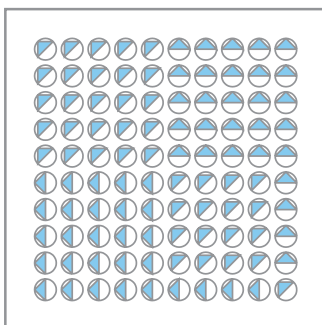

S  1-vägs

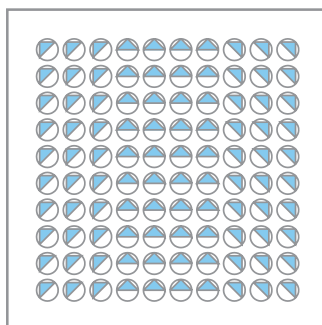

S  Vertikal

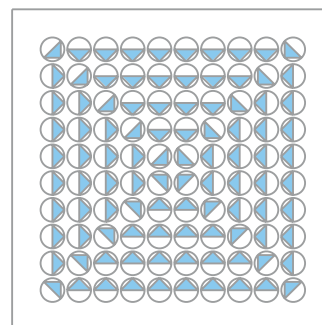



De flesta av oss tillbringar större delen av tiden inomhus. Inomhusklimatet är avgörande för hur vi mår, hur mycket vi orkar och om vi håller oss friska.

Vi på Lindab har därför gjort till vår viktigaste uppgift att bidra till ett inomhusklimat som förbättrar människors liv. Det gör vi genom att utveckla energieffektiva ventilationslösningar och hållbara byggprodukter. Vi vill också bidra till ett bättre klimat för vår planet genom att arbeta på ett sätt som är hållbart för både människor och miljön.

[Lindab](#) | För ett bättre klimat