



Lindab **Plexus**

Snabbguide installation



Snabbguide installation

Plexus

Symboler



Varmt vatten



Handdragning



Kallt vatten



Tung last – 2 personer krävs – vi rekommenderar att lyftutrustning används vid montering.

Verktyg



Kniv



Handskar



Skor med mjuka sulor

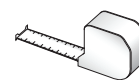

Måttband

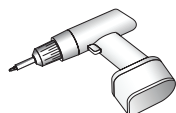

Borrmaskin

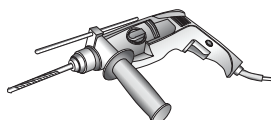

Slagborrmaskin

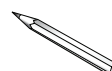

Penna

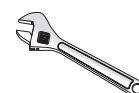

Skiftnyckel

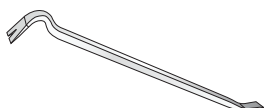

Kofot

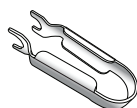

Tectite-verktyg, 12 mm
(Ordernr: 884087)



Tectite-verktyg, liten, 12mm
(Ordernr: 646881)

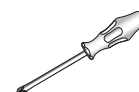

Skruvmejsel

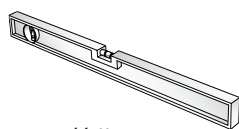

Vattenpass



Lindab PC410
(Ordernr: 103344)

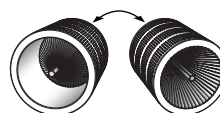

Avgradningsverktyg

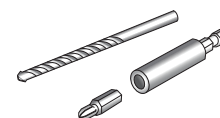

Bits och borrar



Dammsugare



Dammvipa

Snabbguide installation

Plexus

Packning och upppackning

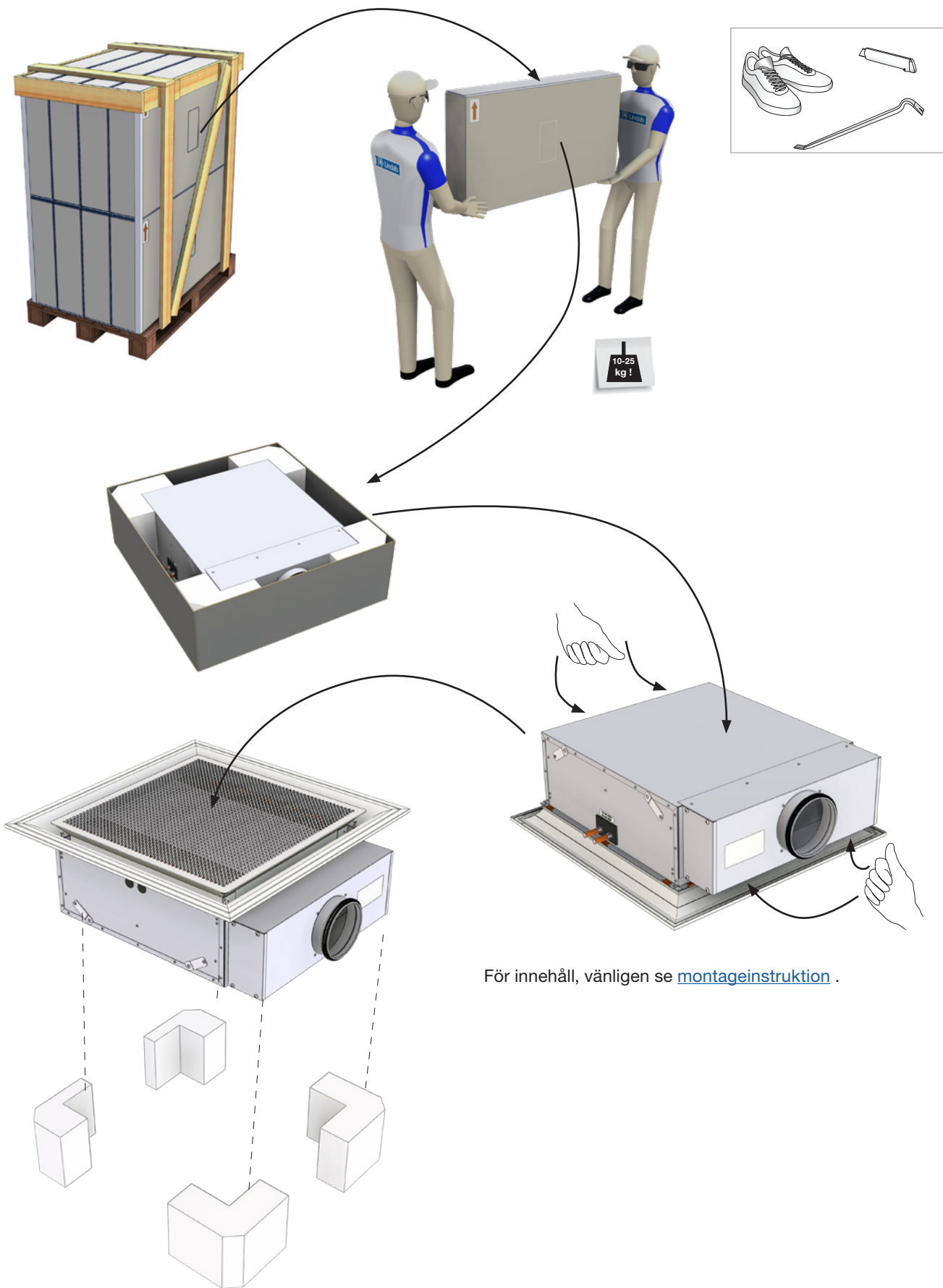

Snabbguide installation

Plexus

Beställningskod etikett

Plexus I
Integrerad

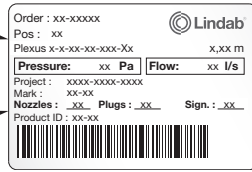
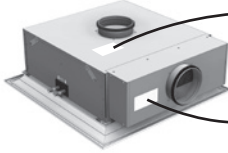

Plexus F
Frihängande

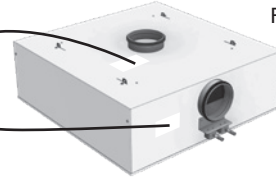

Beställningskod

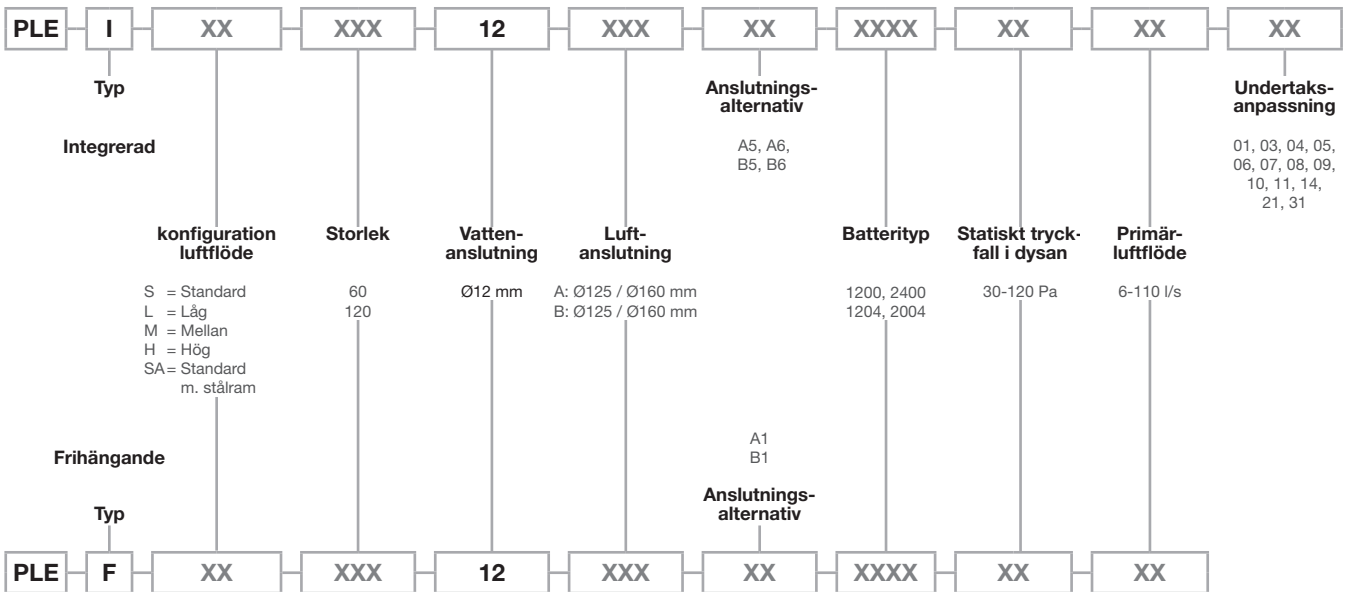

Produktmärkning

JetCones

| Date | P _{stat} [Pa] | q _v [l/s] | 1 | 2 | 3 | 4 | Signature |
|------|------------------------|----------------------|---|---|---|---|-----------|
| | | | | | | | |

Rev. 04-2012



Snabbguide installation

Plexus

Dimensioner

Alle mått i mm.

Plexus I 60

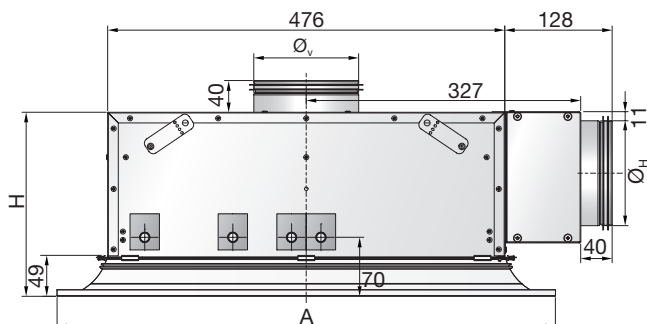

Plexus F

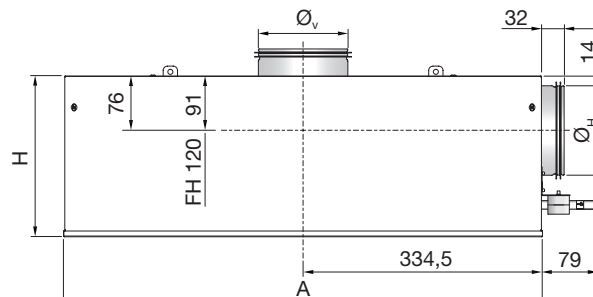

Plexus I 120

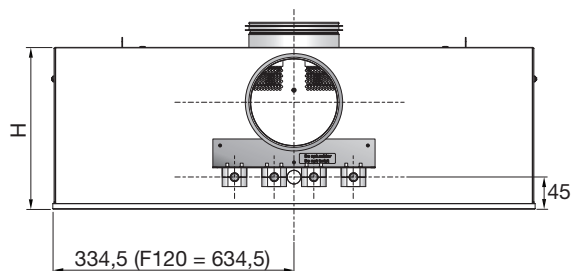
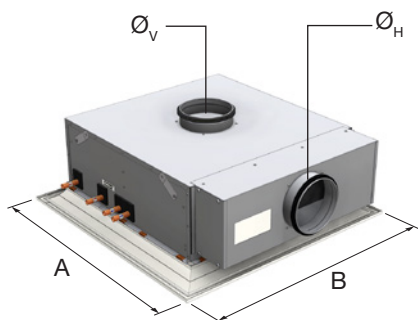
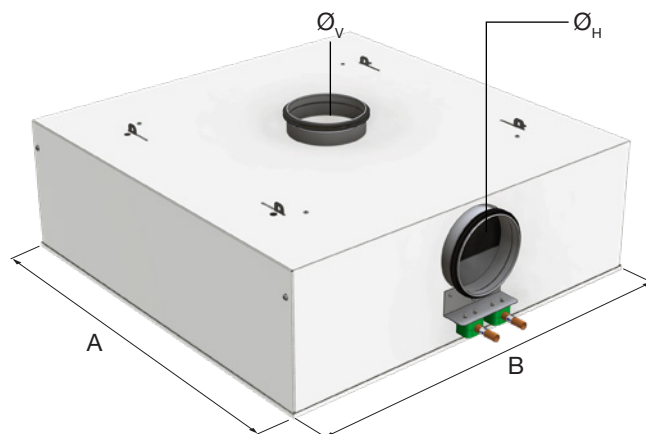
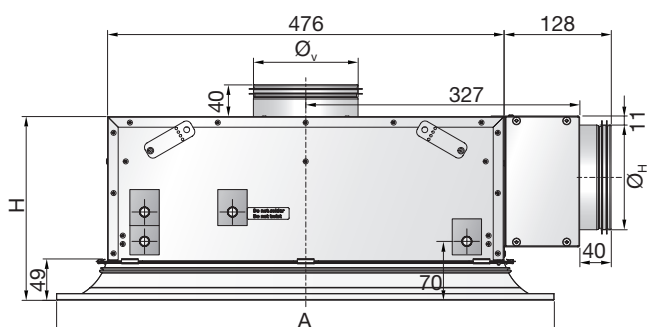

| Typ | Dimensioner [mm] | | | | |
|----------------|------------------|------|-----|----------------|----------------|
| | A* | B* | H | Ø _H | Ø _V |
| I (S/SA) 60 | 594 | 594 | 220 | 125 | 125 |
| I (L, M, H) 60 | 594 | 594 | 220 | 125 | 160 |
| I (S/SA) 120 | 594 | 1194 | 220 | 125 | 160 |
| I (H) 120 | 594 | 1194 | 250 | 160 | N/A |

Tabell 1. Plexus I dimensioner.

| Typ | Dimensioner [mm] | | | | |
|----------------|------------------|------|-----|----------------|----------------|
| | A | B | H | Ø _H | Ø _V |
| F (S) 60 | 669 | 669 | 225 | 125 | 125 |
| F (L, M, H) 60 | 669 | 669 | 225 | 125 | 160 |
| F S 120 | 669 | 1269 | 225 | 125 | 160 |
| F H 120 | 669 | 1269 | 255 | 160 | N/A |

Tabell 2. Plexus F dimensioner.

* Mått A och B beror på taksystem.
Se [monteringsanvisning](#) 5.2.1.

Snabbguide installation

Plexus

Materialdata

| Typ | Plexus |
|---------------------|-------------------|
| kopparrör, kvalitet | EN-12735-2 CU-DHP |
| Tryckklass | PN10 |

Tabell 3. Kvalitet och Tryckklass.

| Typ | Function | Batterityp CC HH | Vatteninnehåll [l] | | |
|------------------------|----------|---------------------|----------------------|-------|-------|
| | | | Kyla | Värme | Total |
| I-60 / F-60 | 2-rör | 24 00 | | | 1,2 |
| I-60 / F-60 | 4-rör | 20 04 | 1,0 | 0,2 | 1,2 |
| I-120 / IH-120 / F-120 | 2-rör | 12 00 | | | 1,3 |
| I-120 / IH-120 / F-120 | 4-rör | 12 04 | 1,3 | 0,4 | 1,7 |

Tabell 4. Vatteninnehåll.

| Type | Funktion | Torrsvikt [kg] |
|--------|----------|----------------|
| | | Total |
| I-60 | 2-rör | 11,6 |
| | 4-rör | |
| F-60 | 2-rör | 17,2 |
| | 4-rör | |
| I-120 | 2-rör | 18,6 |
| | 4-rör | 20 |
| F-120 | 2-rör | 28,9 |
| | 4-rör | 30,3 |
| IH-120 | 2-rör | 19,6 |
| | 4-rör | 21 |
| FH-120 | 2-rör | 29,9 |
| | 4-rör | 31,3 |

Tabell 5. Vikt.

Miljövarudeklaration

Följ länkarna nedan:

- [Byggvarudeklaration](#)
- [Försäkran om överensstämmelse.](#)
- [Eurovent certifikat](#)

3.6 Tryckklass

Samtliga produkter i Lindabs sortiment för vattenburen värme/kyla, produceras enligt tryckklass PN10 enligt EN 1333: 2006.

Detta betyder att arbetstrycket för produkterna vid en vattentemperatur på 20°C inte får överstiga 10 bar.

Snabbguide installation

Plexus

Vattenanslutningar

Plexus I 60

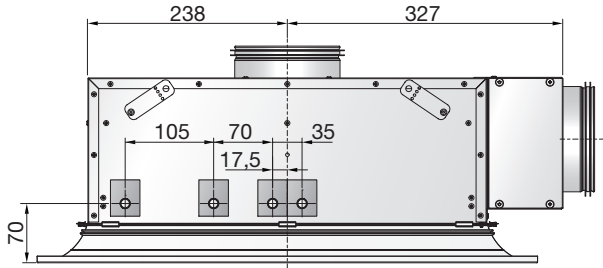

I-60: 2-rörs batteri, kyla eller värme (standard).

Plexus I 120

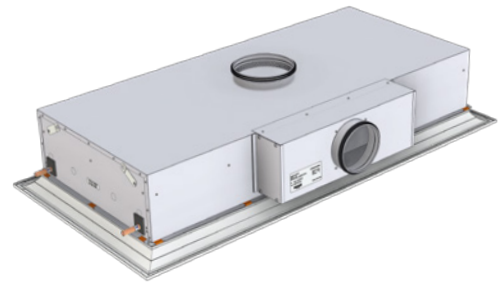
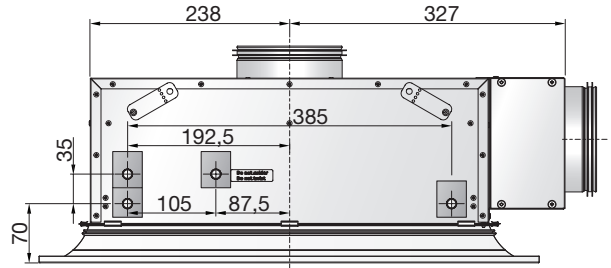

I-120: 2-rörs batteri, kyla eller värme (standard).

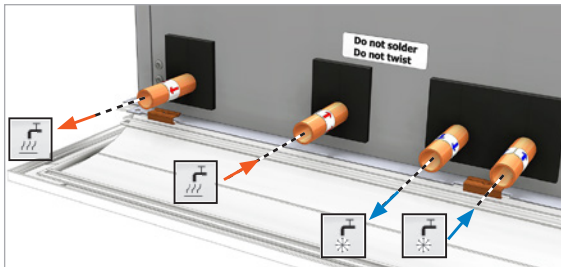
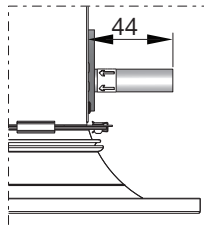

I-60: 4-rörs batteri, kyla och värme (plusfunktion).

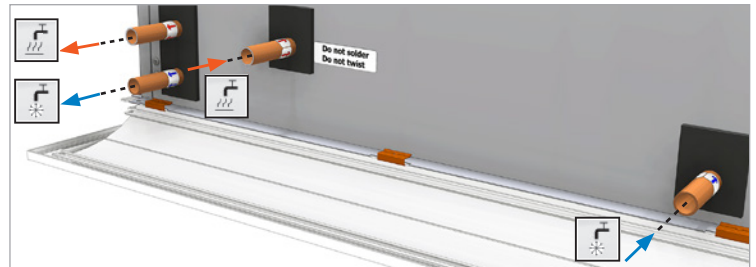

I-120: 4-rörs batteri, kyla och värme (plusfunktion).

Plexus F 60

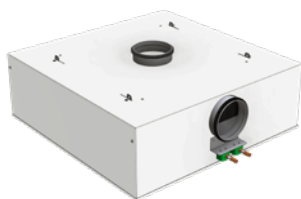

F-60: 2-rörs batteri, kyla eller värme (standard).

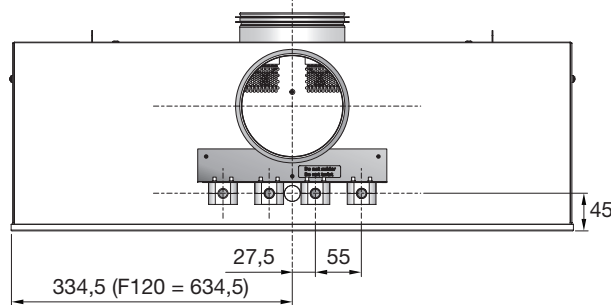

Plexus F 120



F-120: 2-rörs batteri, kyla eller värme (standard).

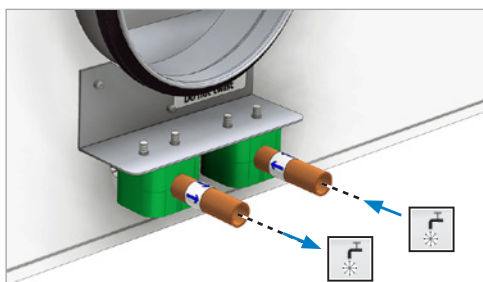

F modell: 2-rörs batteri (standard).

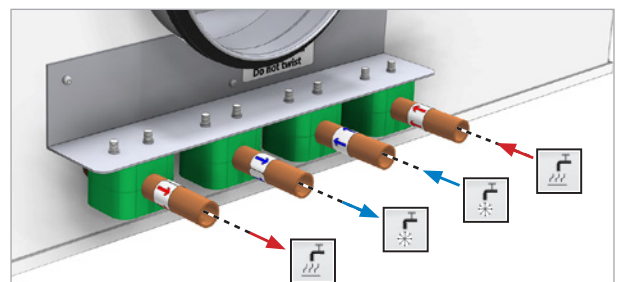
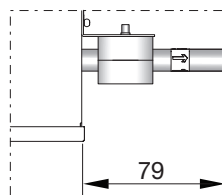

F modell: 4-rörs batteri (plusfunktion).

Snabbguide installation

Plexus

Möjliga anslutningar för tilluft

Plexus I-60
A: Ø125 mm.

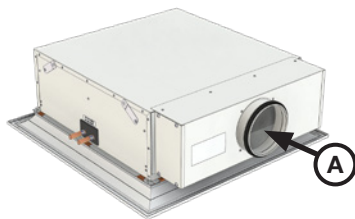

Plexus I-60
B: S Ø125 mm,
B: L/M/H Ø160 mm.

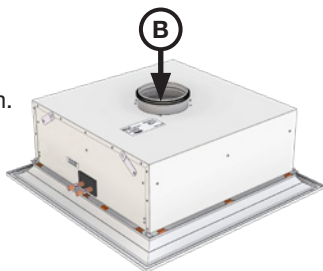

Plexus F-60
A: Ø125 mm.

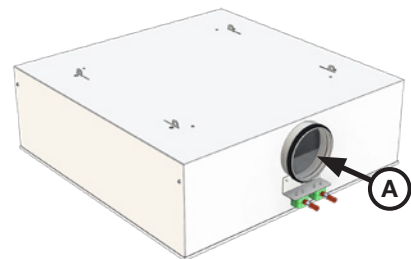

Plexus F-60
B: S Ø125 mm,
B: L/M/H Ø160 mm.

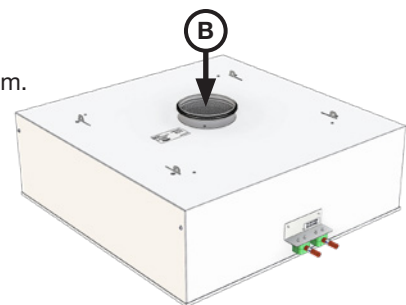

Plexus I-120
A: Ø125 mm.

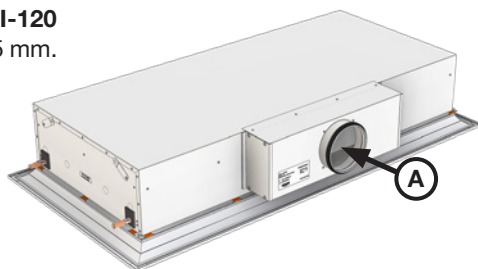

Plexus I-120
B: Ø160 mm.

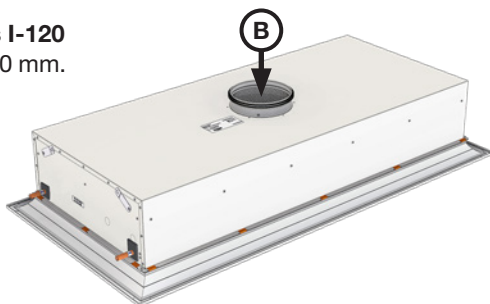

Plexus F-120
A: Ø125 mm,
Plexus FH-120
A: Ø160 mm.

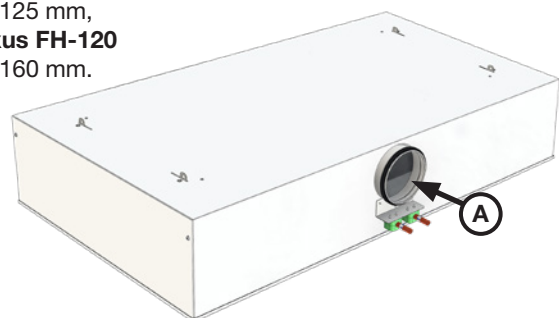

Plexus F-120
B: Ø160 mm.
Plexus FH-120,
B: Inte möjlig.

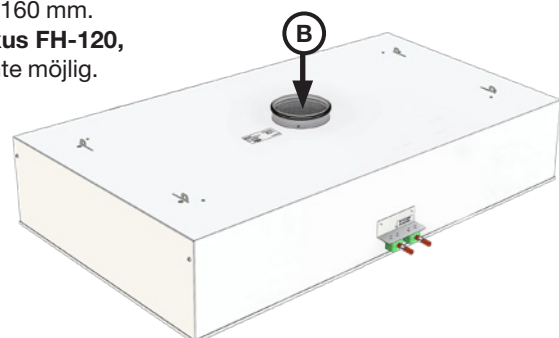

Plexus IH-120
A: Ø160 mm.
B: Inte möjlig.

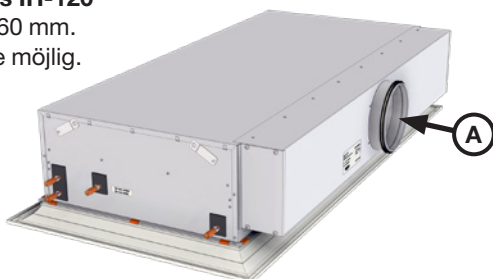

Snabbguide installation

Plexus

Vatten in- och utloppsanslutningar

Möjliga anslutningar för vattenburen kyla eller värme (två anslutningsrör, standard)

Plexus I-60

A5, A6, B5, B6

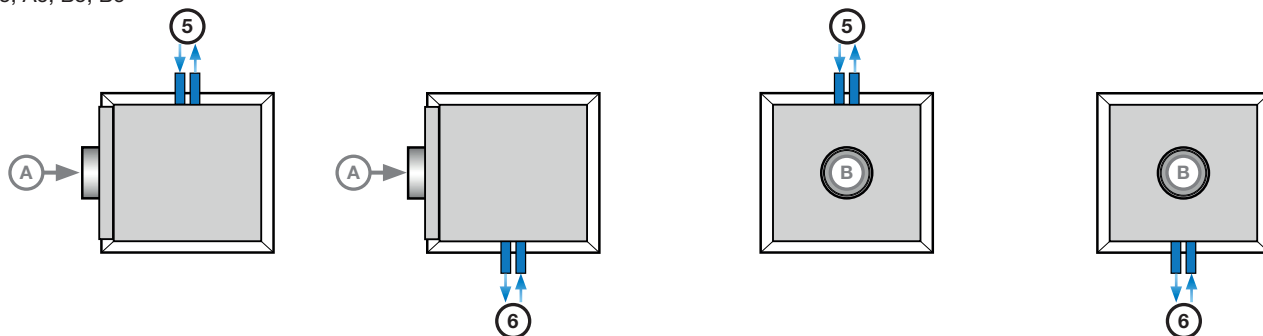

Plexus I-120

A5, A6, B5, B6

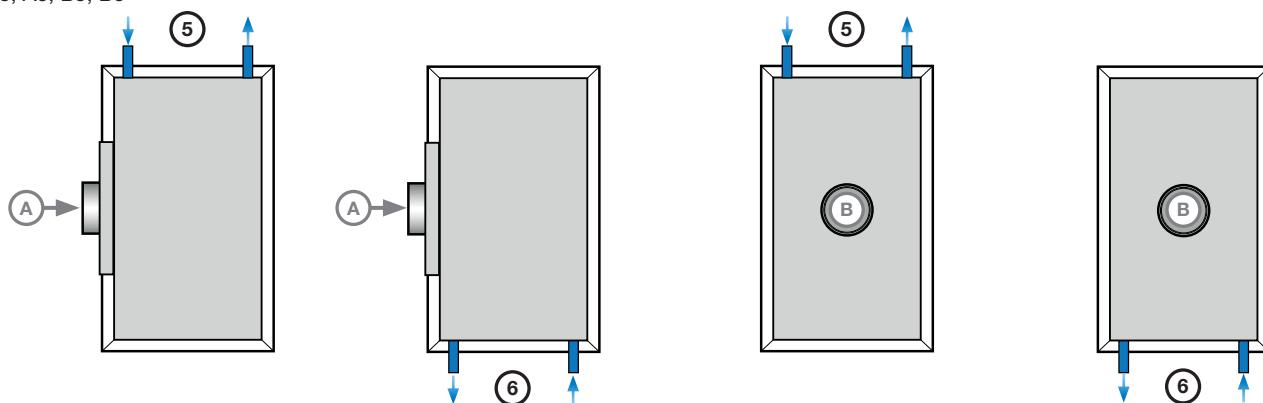

Plexus IH-120

A5, A6

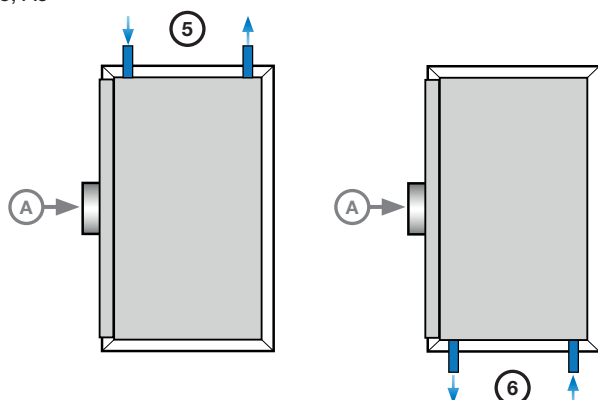

Plexus F-60

A1, B1

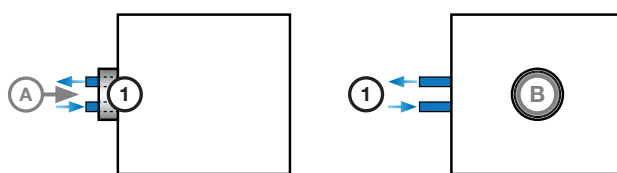

Plexus F-120 / FH-120

A1

Plexus F-120

B1

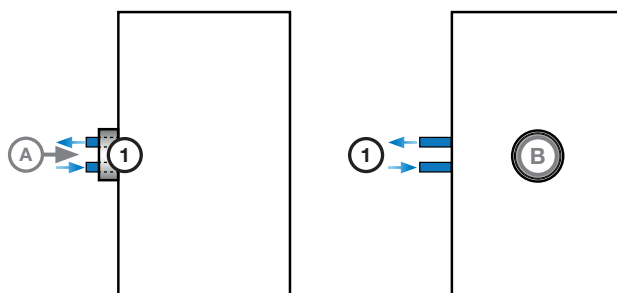

Snabbguide installation

Plexus

Vatten in- och utloppsanslutningar

Möjliga anslutningar, vattenburen kyla och värme (fyra anslutningsrör, Plusfunktion)

Plexus I-60

A5, A6, B5, B6

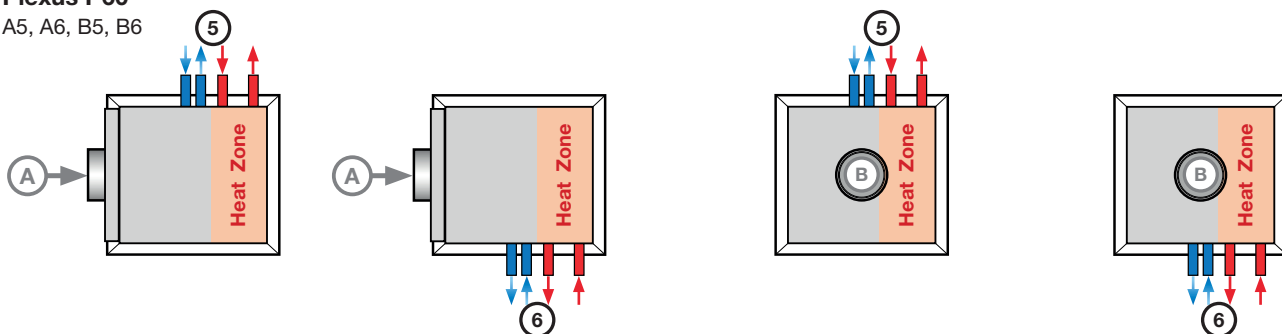

Plexus I-120

A5, A6, B5, B6

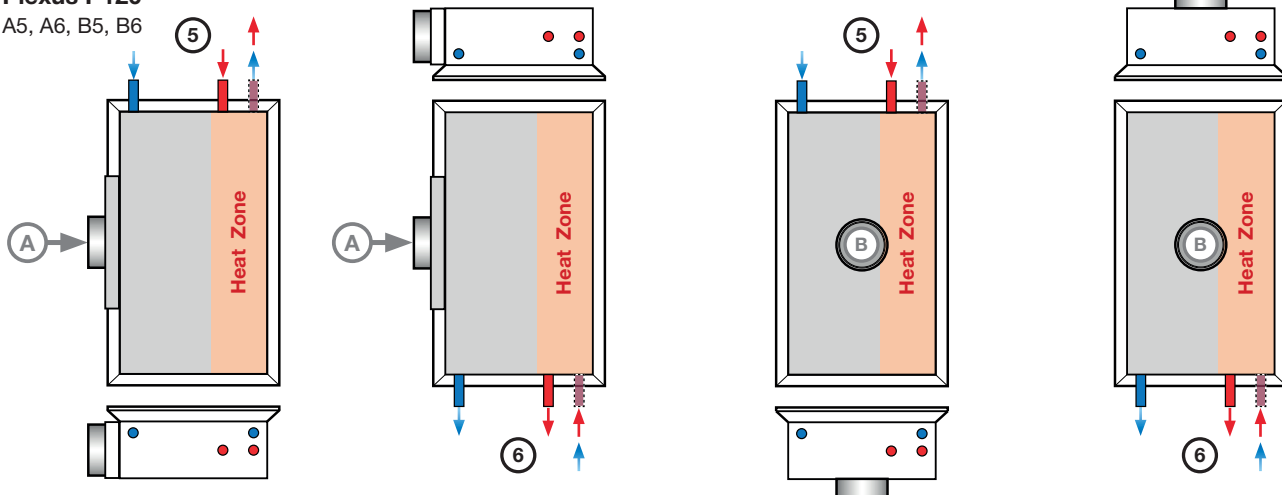

Plexus IH-120

A5, A6

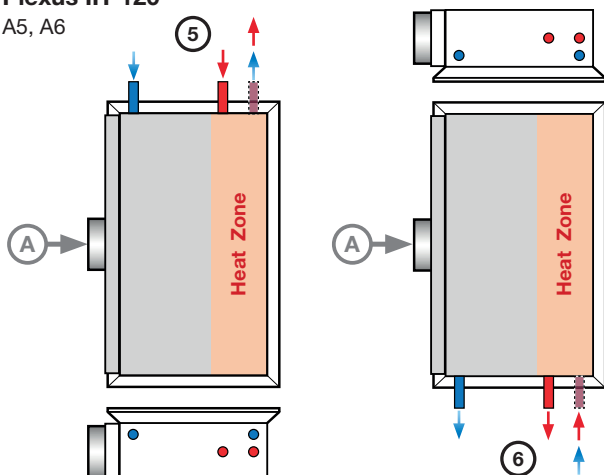

Plexus F-60

A1, B1



Plexus F-120 / FH-120

A1

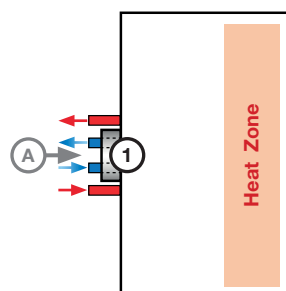

Plexus F-120

B1

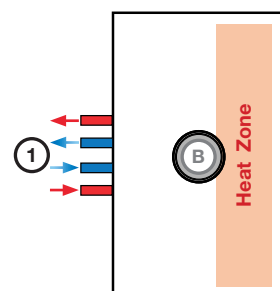

Snabbguide installation

Plexus

Elektriska kopplingar och ventiler

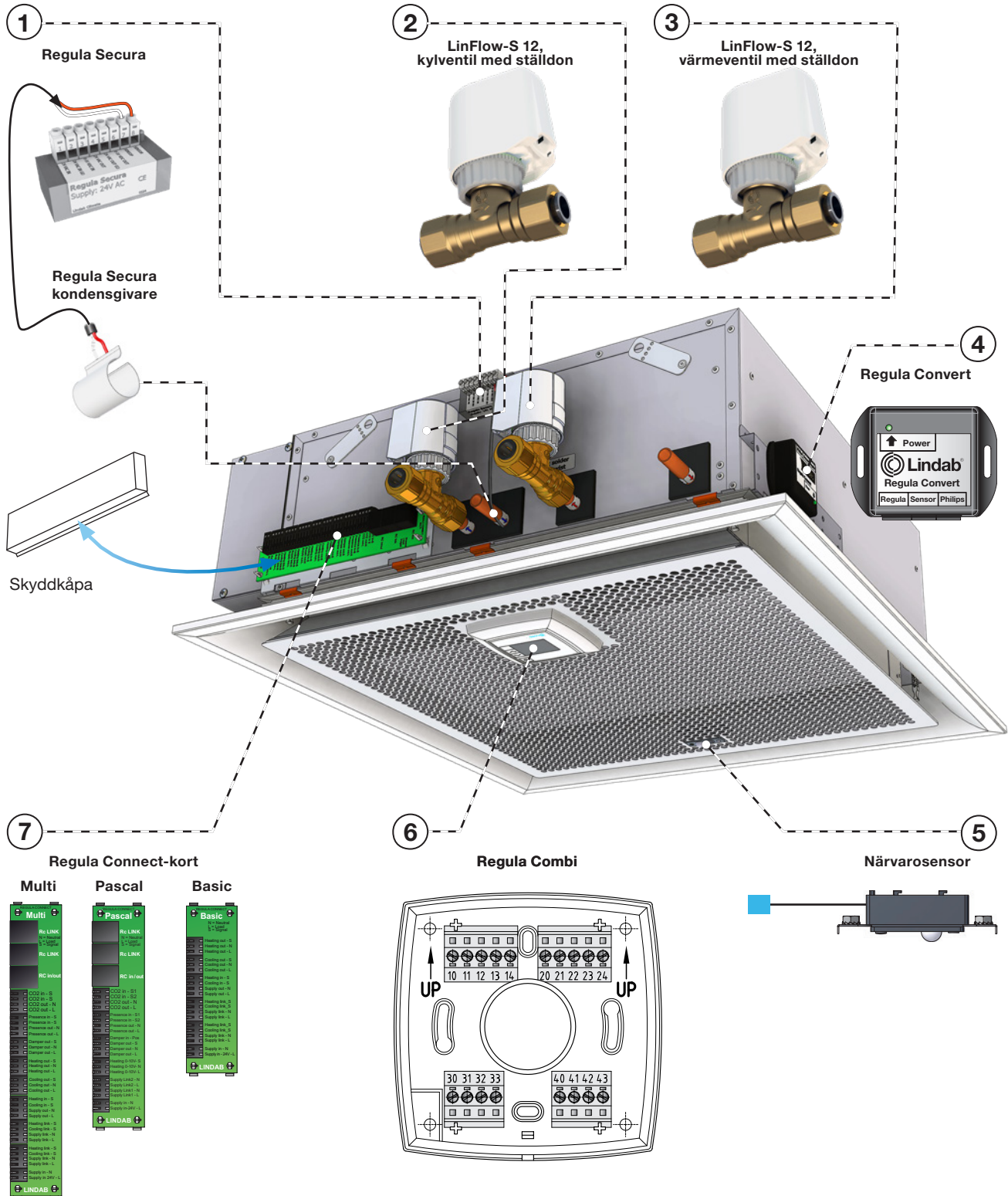

(Skyddskåpor som tillval)

Snabbguide installation

Plexus

Före montering

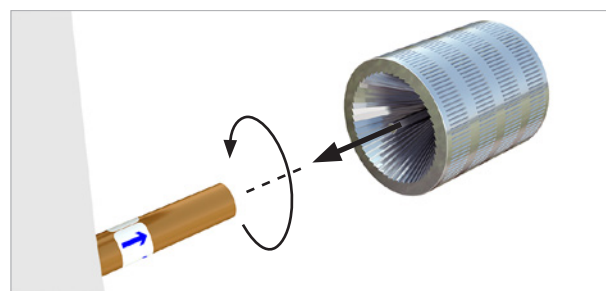
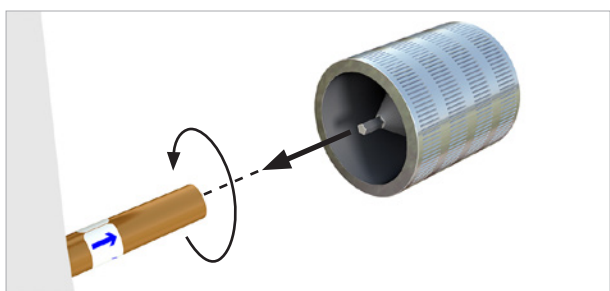
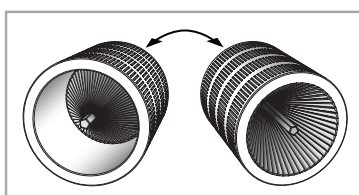
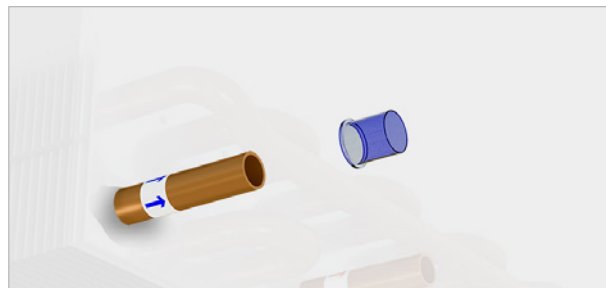

Flexibla slangar och push-on ventiler

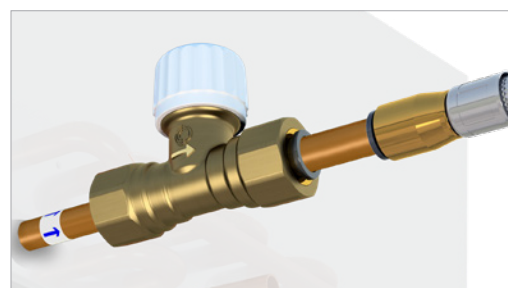
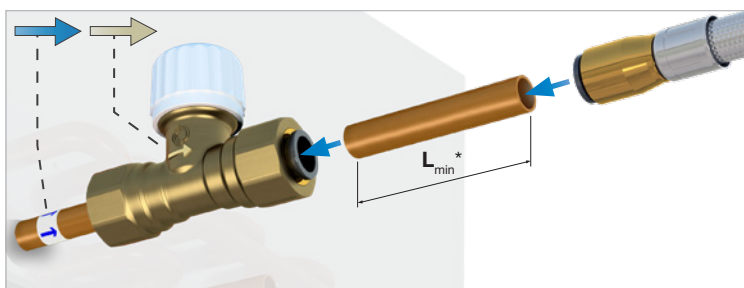
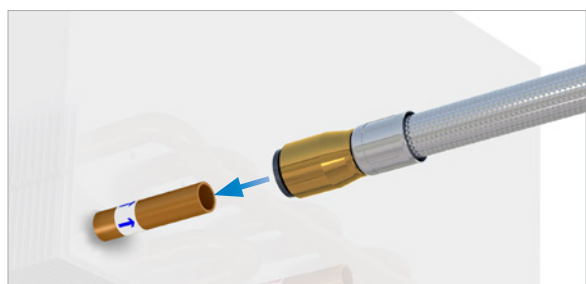

* $L_{min} = 70 \text{ mm}$ (Säkerställer korrekt insättningsdjup samt möjlighet att demontera anslutning vid behov).
 Lindab flexibla slangar fins även med slät, rak ände för att ansluta direkt till Push-fit anslutning.

Snabbguide installation

Plexus

Montering av produkt

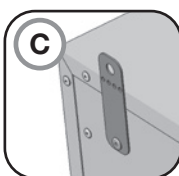
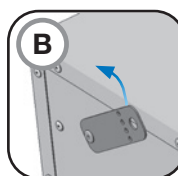
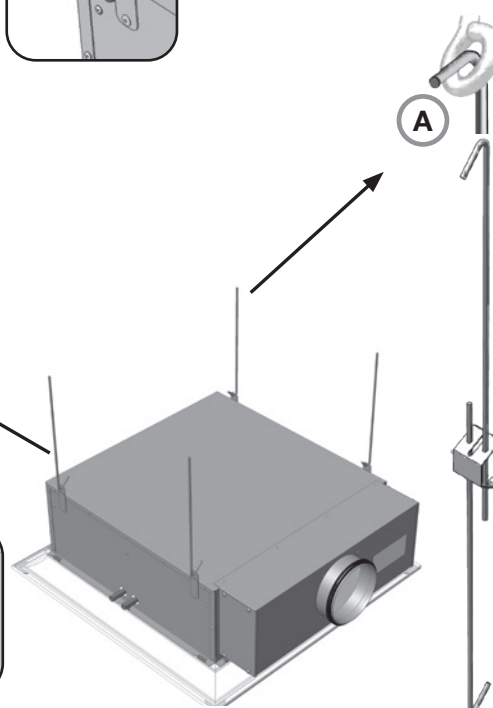
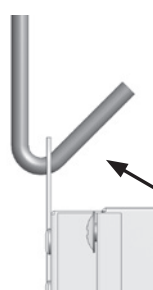
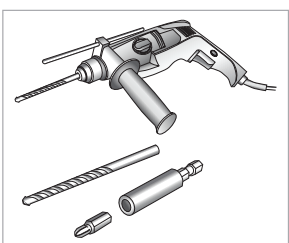
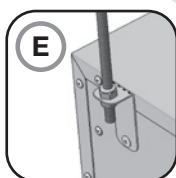
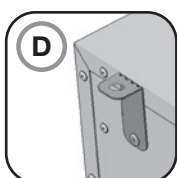
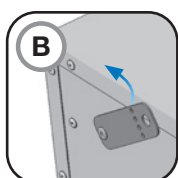
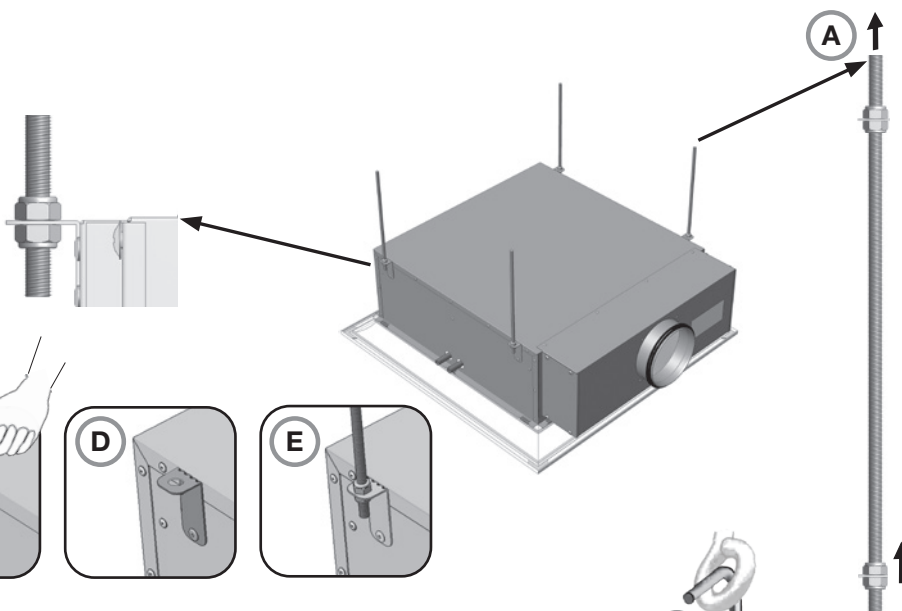
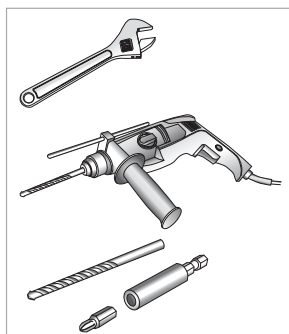
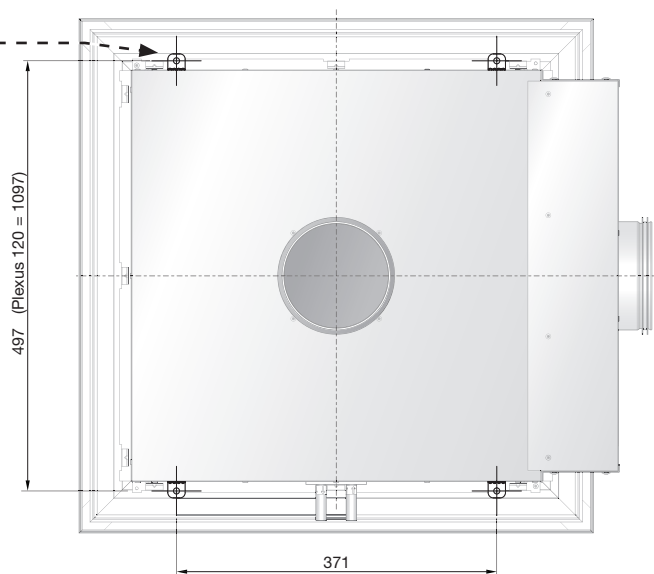
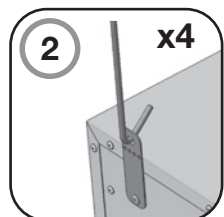
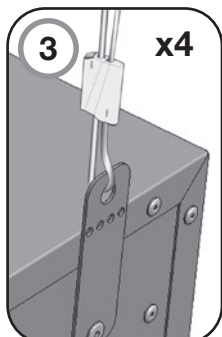
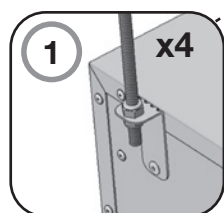

Snabbguide installation

Plexus

Reglage för JetCones

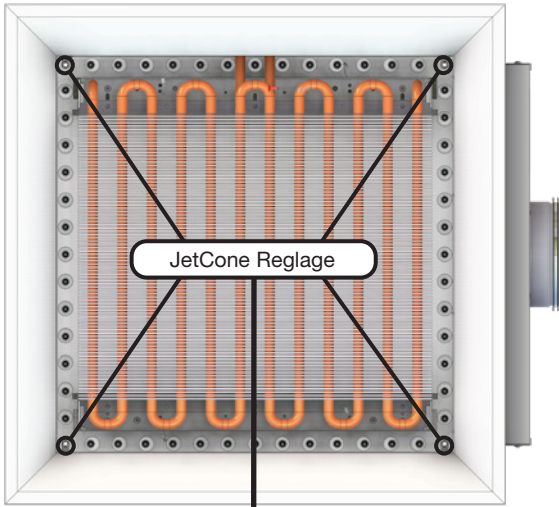

JetCone-reglage 1 i plast

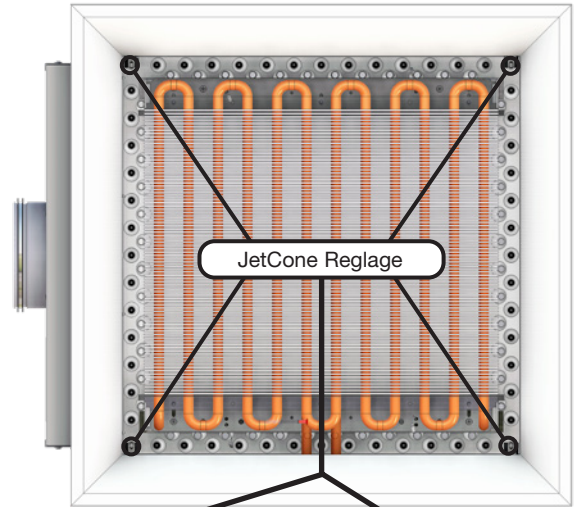

JetCone-reglage 2 i plast

JetCone-reglage i aluminium

- Pos. 0**
Minsta position
JetCone
20% luftflöde.
- Pos. 5**
Standard
inställning
50% öppen
70% luftflöde.
- Pos. 9**
Max. öppen
JetCone
100% luftflöde.

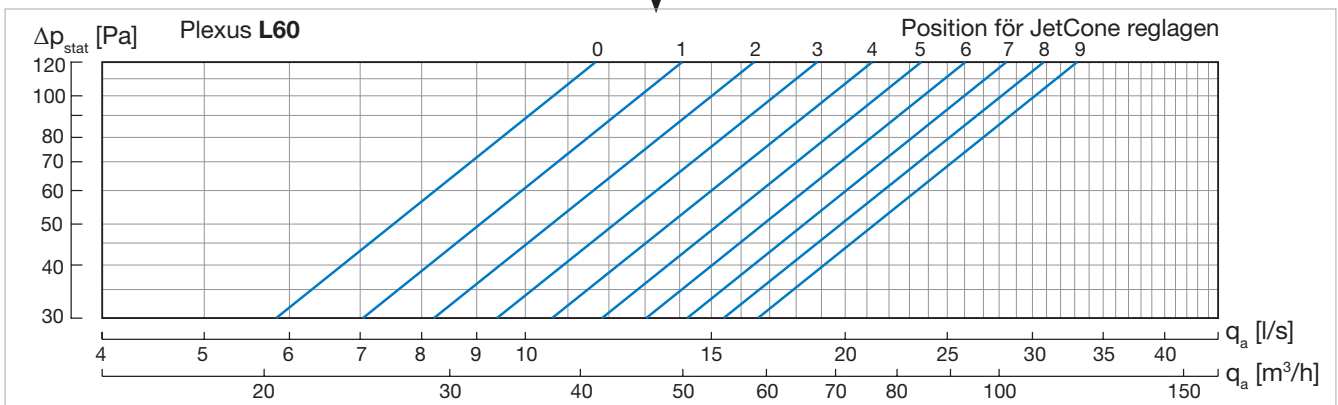
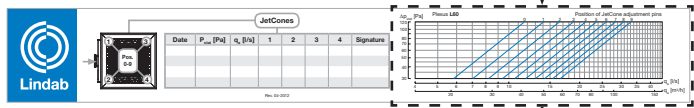
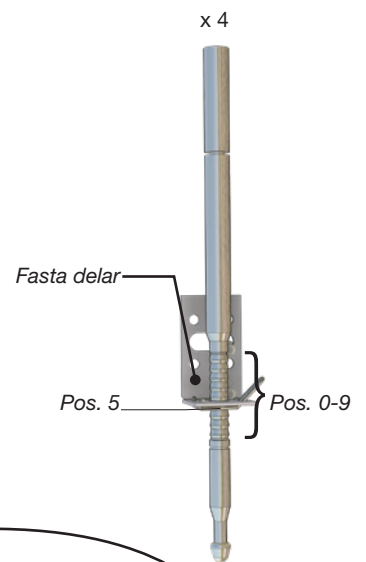
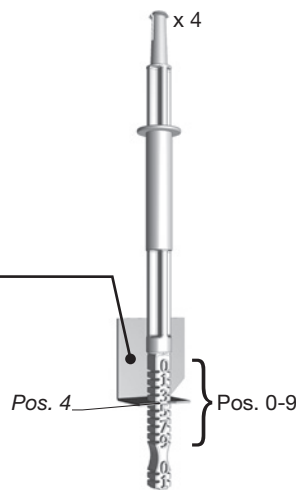

Snabbguide installation

Plexus

Mäta dysans statiske tryck och luftrycket

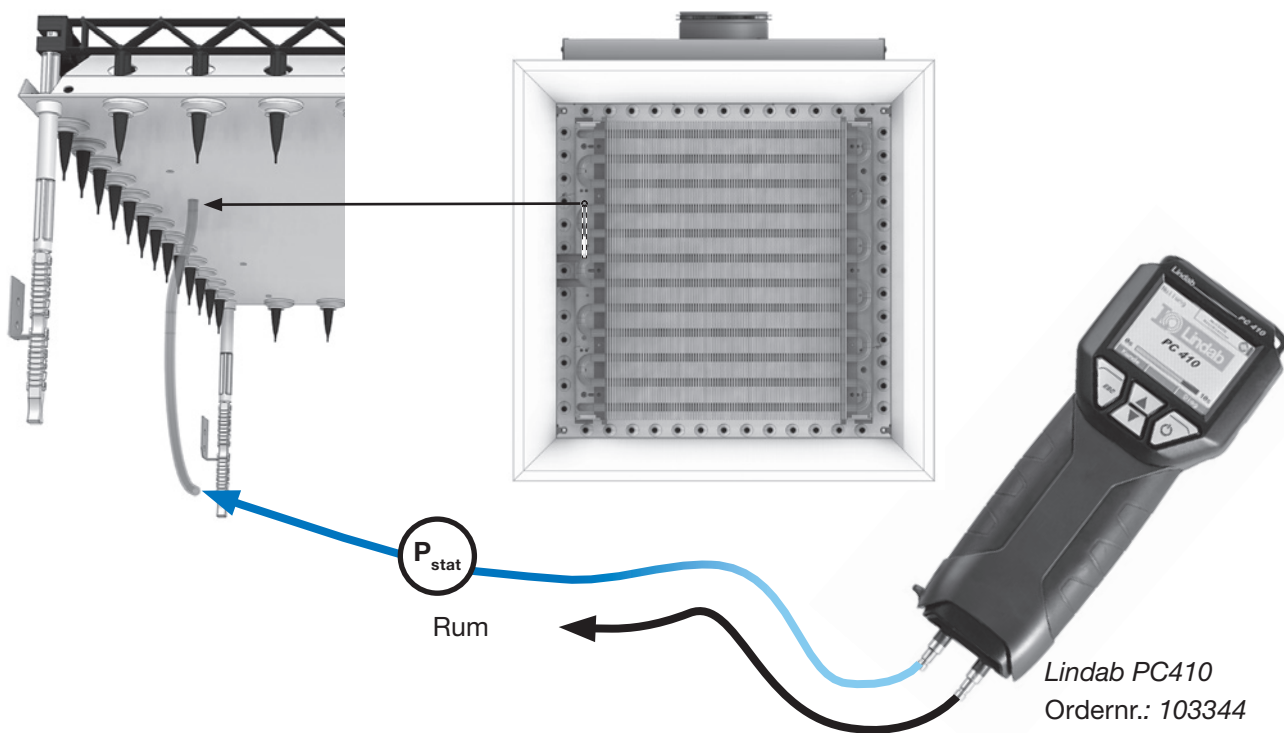

Underhåll

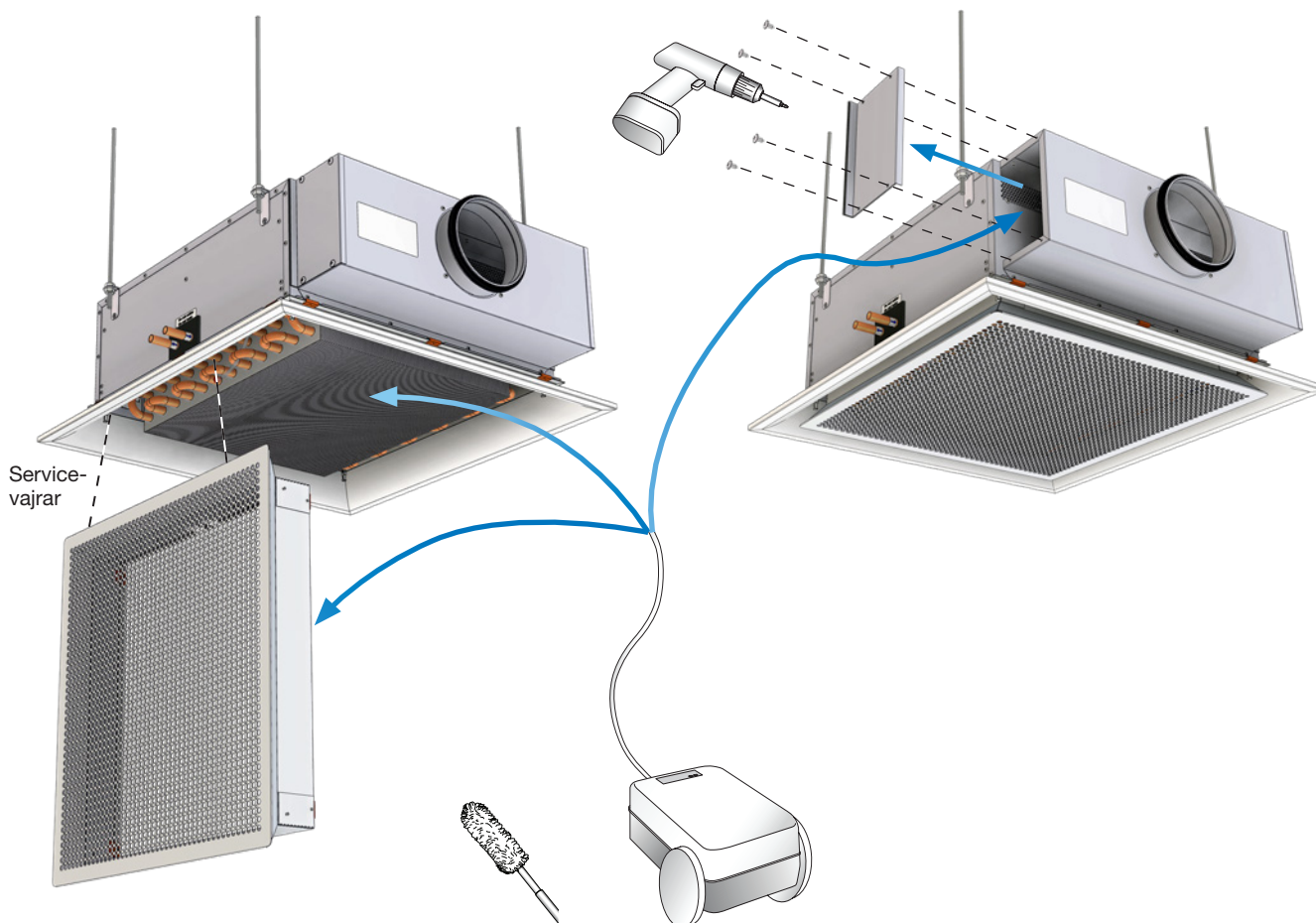



De flesta av oss tillbringar större delen av tiden inomhus. Inomhusklimatet är avgörande för hur vi mår, hur mycket vi orkar och om vi håller oss friska.

Vi på Lindab har därför gjort till vår viktigaste uppgift att bidra till ett inomhusklimat som förbättrar människors liv. Det gör vi genom att utveckla energieffektiva ventilationslösningar och hållbara byggprodukter. Vi vill också bidra till ett bättre klimat för vår planet genom att arbeta på ett sätt som är hållbart för både människor och miljön.

Lindab | För ett bättre klimat